

8513-ME (5 PLY)

AUTONOMY DOOR, PARTICLE CORE (SEE 8500-ME)

FEATURES:

Built to rigorous industry standards, our Autonomy door features uniform hardware and framing to facilitate every step of your project. This sturdy Autonomy door is readily adaptable to all renovation work and fits existing frames with conventional hardware. Install according to the instructions provided.

EASE OF USE

Thanks to the new ball-bearing based pivot system and high-performance tracking, it opens smoothly and quietly.

Door projection is reduced by 2/3 to facilitate lever (knob) use at all times.

A well-designed, attractive and efficient way to optimize the use of every square foot.

Can be retrofitted to existing frames when renovating.

WARRANTY: Limited Lifetime

NOTES

20 min fire rating not available.

STC sound rating not available.

For construction details, see 8500.

This product comes equipped with gear hinge, ultra-robust adjustable stainless steel pivots on ball bearings, a track and a finger guard.

Dimensions are nominal before trimming.

OPTIONS

Wood veneer glued to plywood veneer (3 ply plywood) (7 ply door).

LEED CONTRIBUTION OPTIONS

EPD

Recycled content

FSC

NAUF or ULEF (on request)

PERFORMANCE MEASUREMENT

ANSI/WDMA 1.5.1A

ANSI A208-1 (particle board LD-1/LD2)

ASTM-D1037 and D198-98 (LSL)

ASTM-D5456-93 (LVL)

AWS

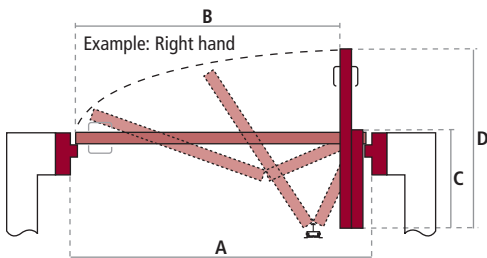
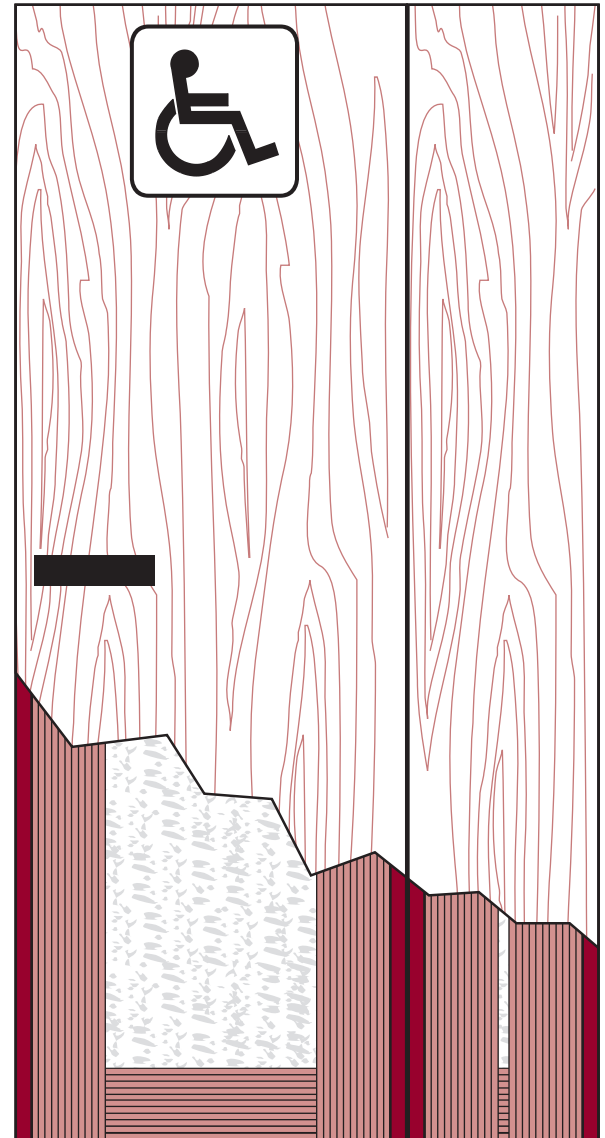

REFERENCE CHART

NET FRAME OPENING SIZE	PASSAGE WIDTH	FINISHED SIZE 1/3 PANEL	FINISHED SIZE 2/3 PANEL
A	B	C	D
36" (914 mm)	30" (762 mm)	11 29/32" (301 mm)	23 13/16" (605 mm)
38" (965 mm)	32" (813 mm)	12 37/64" (320 mm)	25 1/64" (635 mm)
40" (1,016 mm)	34" (864 mm)	13 15/64" (336 mm)	26 31/64" (673 mm)
42" (1,067 mm)	36" (914 mm)	13 29/32" (353 mm)	27 13/16" (707 mm)
44" (1,118 mm)	38" (965 mm)	14 37/64" (370 mm)	29 9/64" (740 mm)
46" (1,168 mm)	40" (1,016 mm)	15 15/64" (387 mm)	30 31/64" (774 mm)
48" (1,219 mm)	42" (1,067 mm)	15 29/32" (404 mm)	31 13/16" (808 mm)

TECHNICAL SPECIFICATIONS - AUTONOMY DOOR

AUTONOMY DOOR INSTALLATION INSTRUCTIONS FOR JOB SITES

Step 1

Using a 1/4" (6 mm) thick wood spacer, fix the angle and the track to the top of the frame with 1 7/8" (32 mm) #8 self-drilling pan head screws. Insert the sliding block "A" into it according to the opening's direction (see Figure 5). It is very important to check whether the stiles and rails of the frame are perpendicular and square; otherwise use a spacer under the rail.

Note: It is preferable to pre-drill holes if a steel frame is used.

Step 2

Securely attach the floor plate to the floor with 1 7/8" (32 mm) #10 flathead screws, aligning it on the interior side against the door stopper (see Figure 6). In the largest opening of the floor plate, place a washer, add the roller bearing and finally put a washer on top of it.

Step 3

Be sure that the pivot "B" (see Figure 1) is screwed as tightly as possible into the door. Insert the pivot "C" (see Figure 2) inside the track and then insert pivot "A" (see Figure 1) in the sliding block. Then place pivot "B" (see Figure 1) in the floor plate.

Step 4

You can now adjust the door height by screwing or unscrewing the pivot "B" (see Figure 1) with a key. Be sure pivot "C" (see Figure 2) slides well inside the track. If not, you must remove the door and adjust pivot "C" (see Figure 2) as required. Screw the nut as much as you can with your fingers toward the door and use the key to screw the axis and lock pivot "C". Repeat Step 3 until the pivots are in the right position and then lock the pivot "B" (see Figure 1) with the key.

Step 5

Install solid neoprene in designated places (see Figure 4).

TECHNICAL SPECIFICATIONS - AUTONOMY DOOR

TECHNICAL DETAILS - JOB SITE

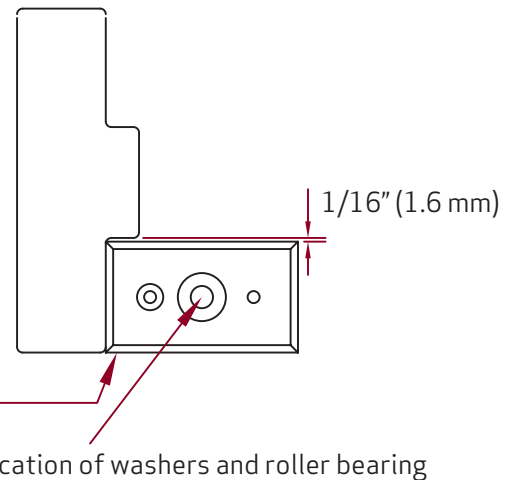
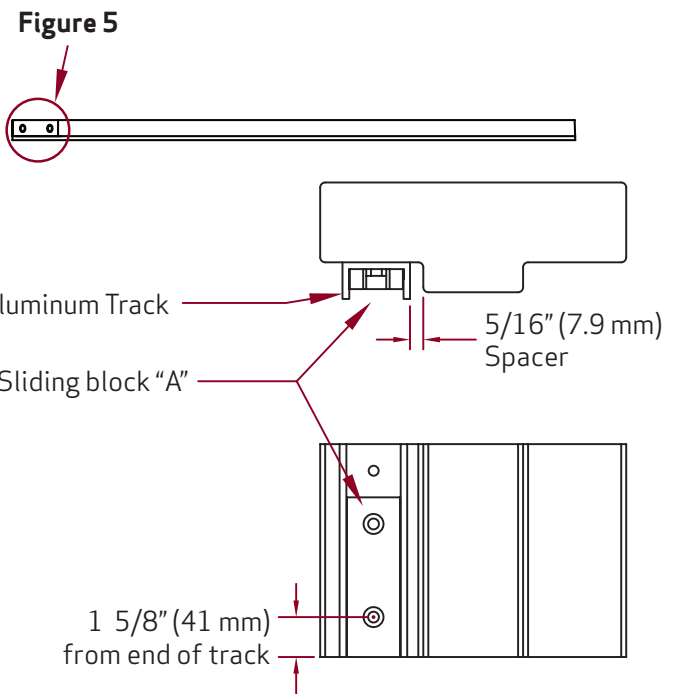
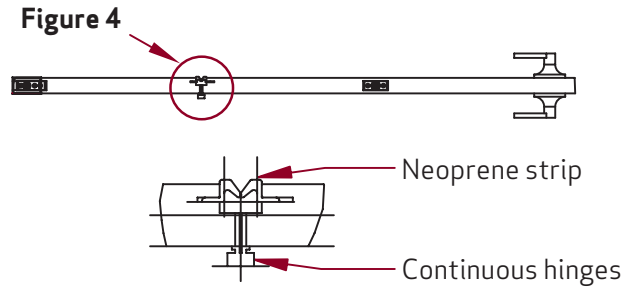
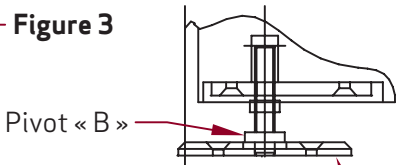
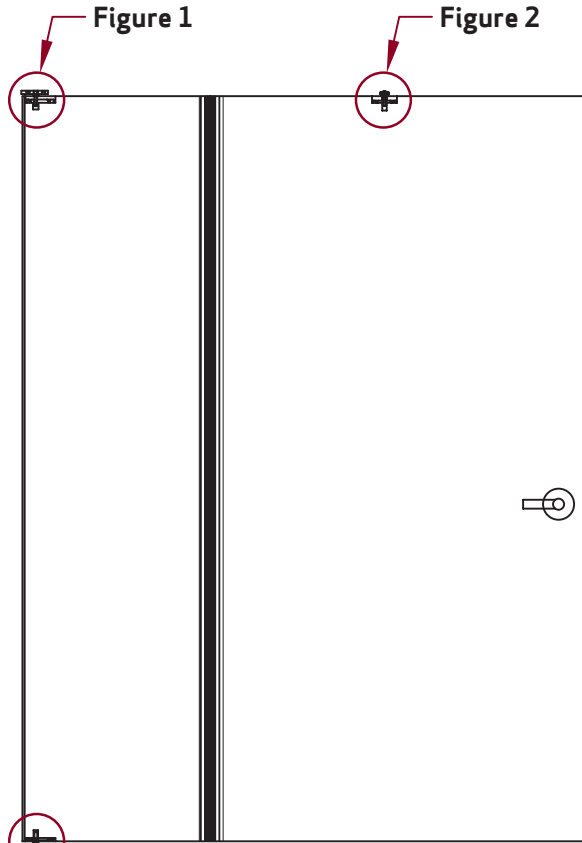
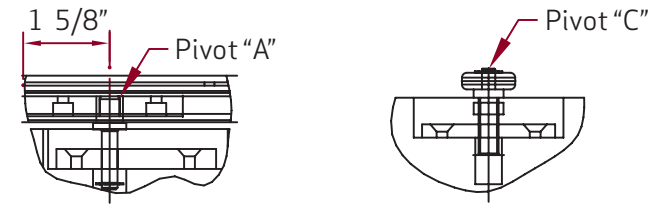

TECHNICAL SPECIFICATIONS - AUTONOMY DOOR

TECHNICAL DETAILS - FACTORY

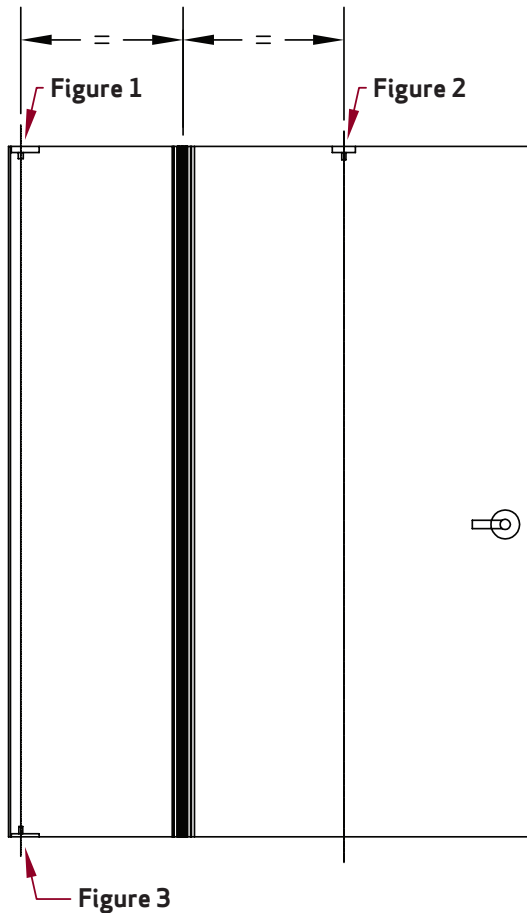
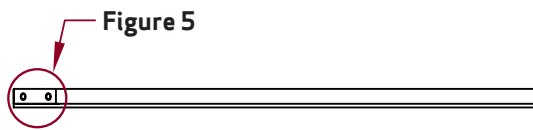
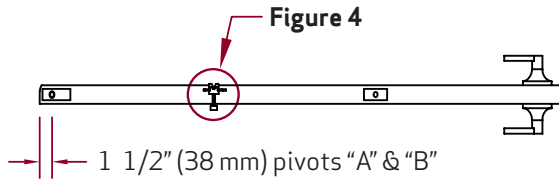

Figure 1

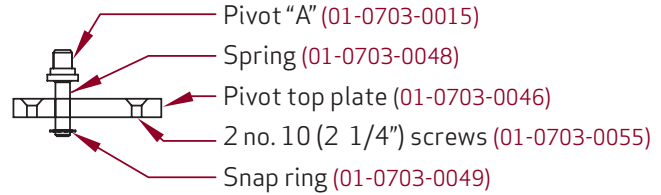

Figure 2*

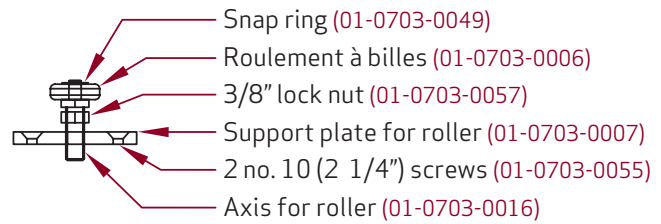

Figure 3*

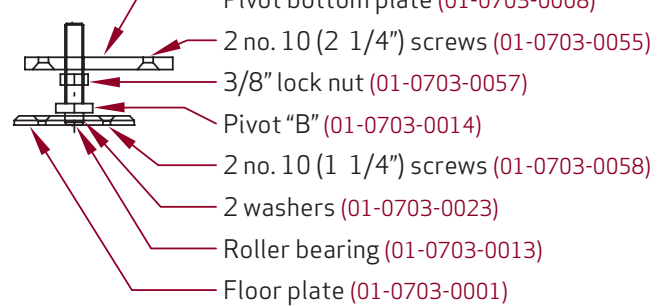

Figure 4

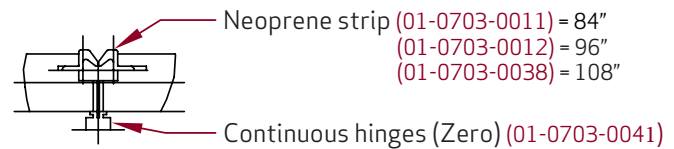
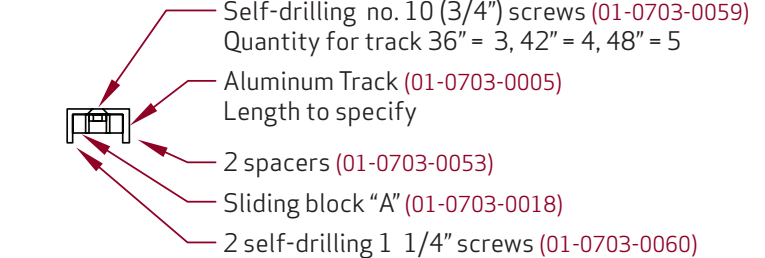

Figure 5



*Optional 3/8" Key (01-0703-0047)



DOOR OPERATION CODES

